

PINNACLE[®]
HIP SOLUTIONS

PINNACLE[®] Hip Solutions

Polyethylene
Surgical Technique





Table of Contents

Surgical technique	Introduction	4
	Templating and Pre-Operative Planning	6
	Surgical Approach – Anterolateral	8
	Surgical Approach – Posterolateral	10
	Acetabular Reaming	12
	Acetabular Shell Trialing and Positioning	13
	Implanting a PINNACLE® Primary Acetabular Shell	20
	Implanting the Acetabular Shell with Screw Fixation	21
	Implanting the Acetabular Shell with Spikes	23
	Polyethylene Liner Insertion and Impaction	24
	Polyethylene Liner Extraction	26
	Functional Assessment	28
	Closure	29
	Tight Exposure and Stability Tips	30
	PINNACLE Hip Performance Instruments	32
Ordering Information	Shell Options	34
	Femoral Head Options	36
	Polyethylene Liner Options	38
	Polyethylene Liner Thickness Chart	42

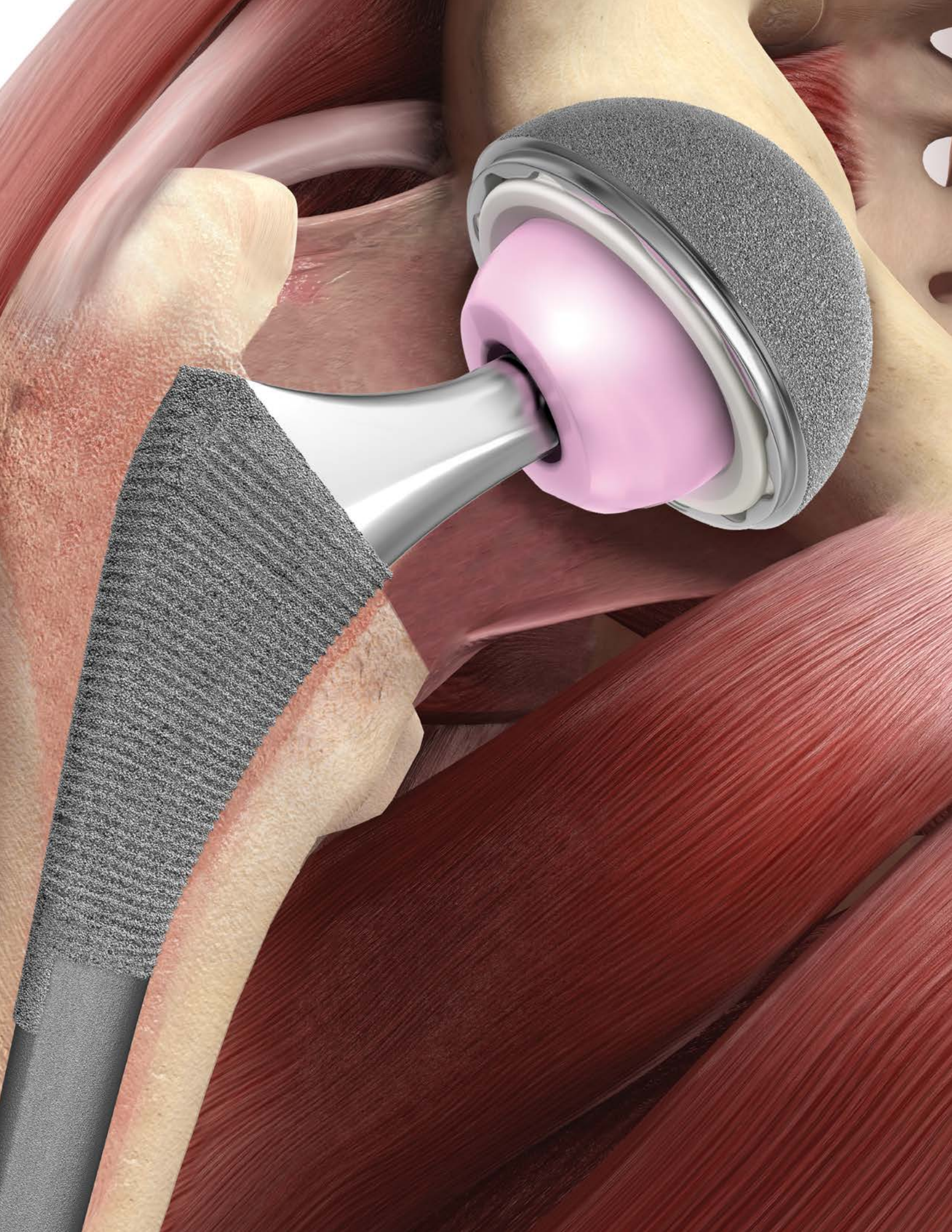

Surgical Technique

The PINNACLE® Acetabular Hip System primary surgical technique has been developed in consultation with an experienced surgeon design team and provides the surgeon with general guidance when implanting the PINNACLE Acetabular Hip System.



Templating and Pre-Operative Planning

The primary goal of total hip arthroplasty is the anatomic reconstruction of the hip joint, resulting in favorable prosthetic joint load and function. Mechanically, the goals are to create a stable articulation with an optimized range of motion, restore biomechanics for muscular efficiency and equalize limb lengths. Meeting these goals begins with a thorough analysis of the hip with comparison to the contralateral side in anteroposterior (A/P) and lateral projections. The desired magnification for all imaging should be 20 percent, which corresponds to the acetate templates provided for the PINNACLE Acetabular System (Figure 1A). Magnification markers taped to the patient's leg at the level of the trochanter will assist in determining actual magnification.

For the A/P projection, place both extremities in 15 degrees of internal rotation to position the head and neck parallel to the coronal plane. Center the beam on the pubic symphysis and ensure the proximal femoral shaft is included in the radiograph. The radiographs should clearly demonstrate the acetabular configuration and the endosteal and periosteal contours of the femoral head, neck and proximal femur.



Frequently, the affected hip is fixed in external rotation, which leads one to underestimate the amount of offset present. In this situation it may be helpful to template the normal hip. Take a Lowenstein lateral with the patient on his/her side, and the trochanter, ankle and knee on the table. Alternately, take a Johnson's lateral for a detailed examination of the anatomic version and anterior osteophytes. Take into consideration any anatomical anomaly, dysplasia, previous fracture or leg length discrepancy.

PINNACLE Acetabular Templates are oriented at 45 degrees and allow measurement of any Hip that can be accommodated by the PINNACLE Acetabular Cup System primary components (38–72 mm). Using the A/P radiograph, position the template at a targeted 40–45 degrees to the inter-teardrop or interischial line so that the inferomedial aspect of the cup abuts the teardrop and the superior-lateral cup is not excessively uncovered (Figures 1B and 1C).

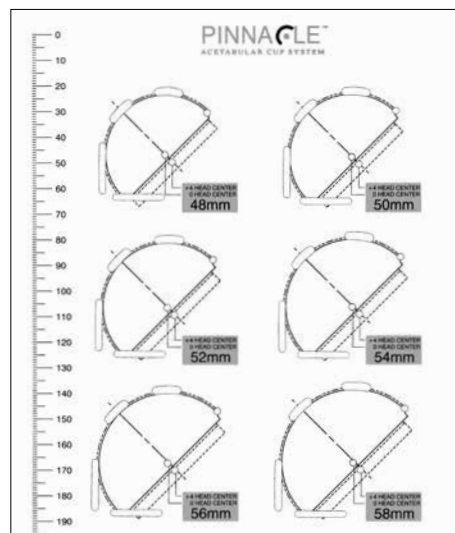

Figure 1A



Figure 1B: Acetabulum with Good Lateral Coverage

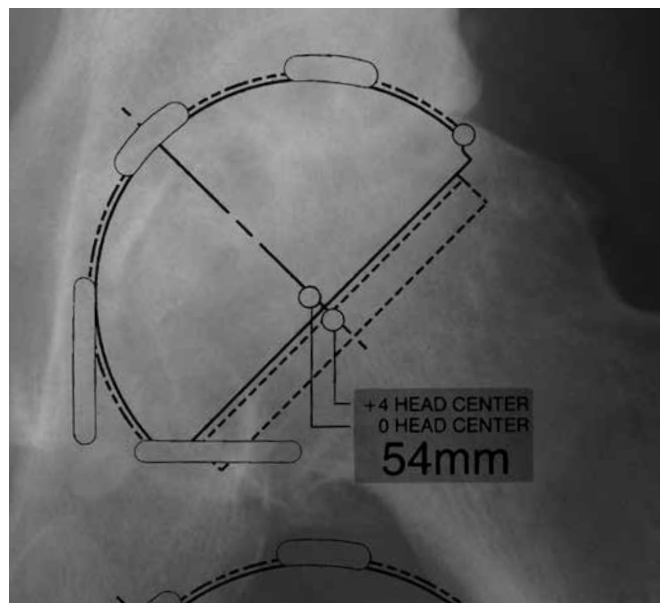

Figure 1C: Positioned Acetabular Template

Anterolateral Surgical Approach

Use the approach with which you are most familiar. PINNACLE Hip System instrumentation was designed to accommodate all surgical approaches.

Skin Incision

For the anterolateral approach, place the patient in the lateral decubitus position and execute a skin incision that extends from distal to proximal, centered over the anterior aspect of the femur, continuing over the greater trochanter tip (Figure 2).



Figure 2: Skin Incision

Fascial Incision

The iliotibial band is split under the skin incision, extending proximally into the gluteus maximus or in between the maximus and the tensor fascia lata muscles (Figure 3).

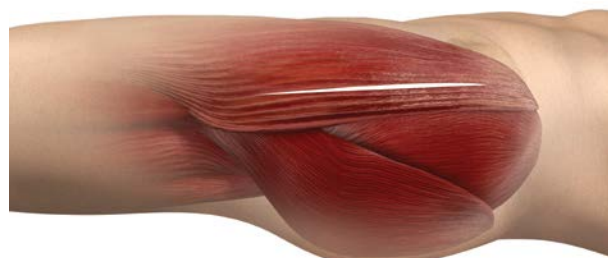

Figure 3: Fascial Incision

Initial Exposure

Palpate the anterior and posterior borders of the gluteus medius. The gluteus medius is split from the trochanter, parallel to its fibers, releasing the anterior 1/2 to 1/3 of the muscle (Figure 4).

The gluteus medius should not be split more than 4 cm from the tip of the greater trochanter. Care must be taken to ensure the inferior branch of the superior gluteal nerve is not damaged. The gluteus minimus is exposed and released either with or separate from the gluteus medius. Flexion and external rotation of the leg facilitates exposure of the hip capsule, which is incised (capsulotomy) or excised (capsulectomy) depending on surgeon preference.

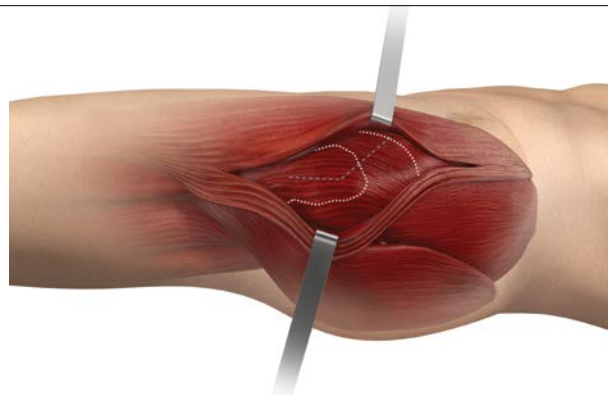

Figure 4: Gluteus Medius Split

Hip Dislocation

Dislocate the hip with gentle adduction, external rotation and flexion. The patient's leg is now across the contralateral leg and the foot is placed in a sterile pouch (not shown, Figure 6). If dislocation is difficult, additional inferior capsule may be released.



Figure 6: Hip Dislocation

Femoral Neck Osteotomy

Expose the femoral neck (Figure 7) and perform a femoral neck osteotomy protocol for the selected femoral prosthesis. Exposure of the acetabulum is accomplished by placing the leg back on the table in slight flexion and external rotation. Use a self-retaining retractor to spread the medius and minimus anteriorly and the hip capsule posteriorly.

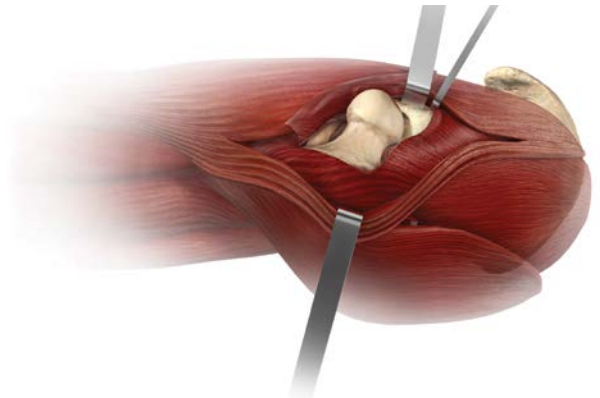

Figure 7: Femoral Neck Exposure

Acetabular Exposure

Carefully place another retractor over the anterior inferior wall of the acetabulum. The final retractor is placed in the acetabular notch beneath the transverse ligament and pulls the femur posteriorly (Figure 8).

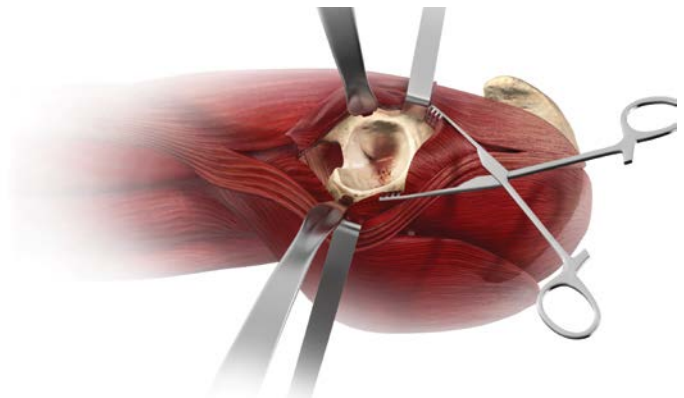

Figure 8: Acetabular Exposure

Posterolateral Surgical Approach

Use the approach with which you are most familiar. PINNACLE Hip System instrumentation was designed to accommodate all surgical approaches.

Skin Incision

For the posterolateral approach, place the patient in the lateral decubitus position. Ensure that the operating table is parallel to the floor and that the patient is adequately secured to the table to improve accuracy.

Center the skin incision over the greater trochanter, carrying it distally over the femoral shaft for about 15 cm and proximally in a gently curving posterior arc of about 30 degrees for about the same distance (Figure 9)



Figure 9: Skin Incision

Fascial Incision

Incise the iliotibial tract distally following the skin incision (Figure 10). Develop the incision proximally by blunt dissection of the gluteus maximus along the direction of its fibers.

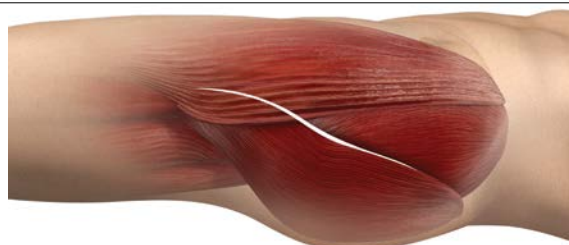

Figure 10: Fascial Incision

Initial Exposure

Place the leg in extension and internal rotation. Utilize self-retaining retractors to facilitate the exposure. Gently sweep loose tissue posteriorly, exposing the underlying short external rotators and quadratus femoris (Figure 11). Identify the posterior margin of the gluteus medius muscle proximally and the tendon of the gluteus maximus distally. Use caution to protect the sciatic nerve.

Incise the quadratus femoris, leaving a cuff of tissue for later repair (Figure 12). This exposes the terminal branch of the medial circumflex artery, which lies deep to the proximal third of the quadratus femoris. Identify the piriformis tendon, the obturator internus tendon (conjoint with the gemelli tendons) and the tendon of the obturator externus, and free them from their insertions at the greater trochanter. The piriformis and the conjoint tendon may be tagged for subsequent reapproximation.

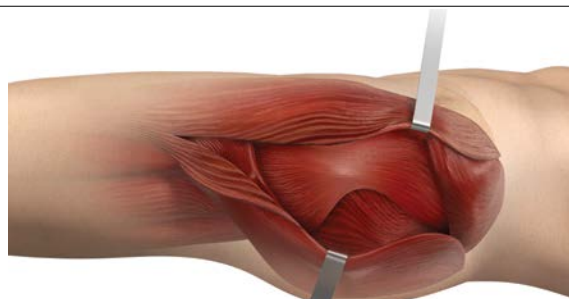

Figure 11: Short External Rotators

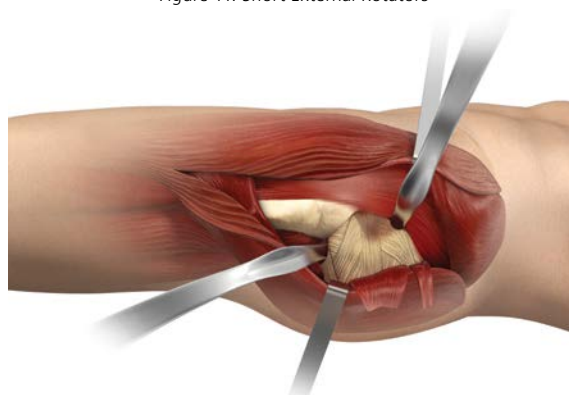

Figure 12: Quadratus Femoris Incision

Posterior Capsulotomy

Retract the short rotator muscles posteromedially together with the gluteus maximus (with consideration to the proximity of the sciatic nerve), thus exposing the posterior capsule (refer to Figure 12). Place cobra retractors anteriorly and inferiorly (Figure 13).

Open the capsule posteriorly starting at the acetabular margin at about 12 o'clock and heading to the base of the neck, around the base of the neck inferiorly and back to the inferior acetabulum, creating a posteriorly based flap for subsequent repair. Excise additional anterosuperior capsule to enhance dislocation of the hip. Alternatively the capsule can be excised (capsulectomy).

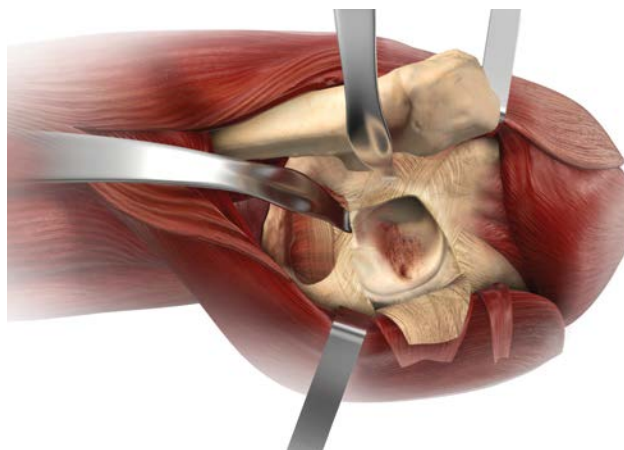

Figure 13: Posterior Capsulotomy

Femoral Exposure

Place a superior pin or retractor in the ilium at approximately the 12 o'clock position. The pin placement is approximately 2 cm superior to the acetabular margin. Caution should be taken not to penetrate the medial wall of the ilium. Measure leg length and dislocate the hip through a combination of flexion, adduction and internal rotation. Osteotomize the femoral neck in accordance with the protocol of the femoral component you have selected.

Acetabular Exposure

One key to proper acetabular component positioning is adequate surgical exposure. Following femoral neck resection, pass a curved retractor, which straddles the pubis, or a blunt cobra over the anterior column to displace the femur anteriorly (Figure 14).

Position a second retractor at the acetabular notch, inferior to the transverse acetabular ligament. An additional retractor may be positioned posteriorly to retract the capsule or short external rotators.

Care should be taken to position retractors to avoid injury to the sciatic nerve. Obtain an unobstructed view of the acetabulum. Excise the entire labrum and remove osteophytes to identify the true anterior and posterior acetabular margins. Release or resect the transverse ligament, together with any accompanying osteophytes. A branch of the obturator artery is often encountered. Clear all soft tissue from the fovea to define the true medial wall.

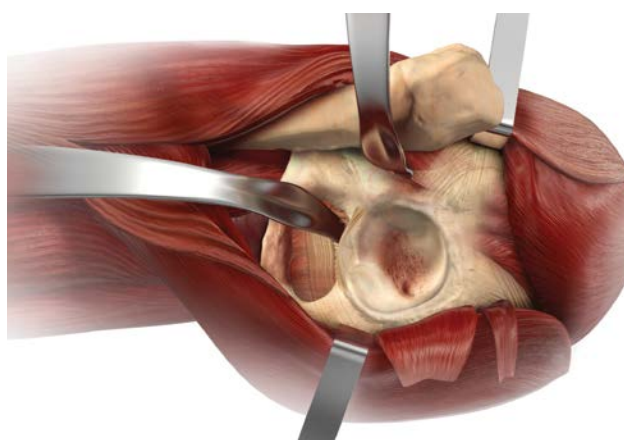

Figure 14: Acetabular Exposure

Note: A detailed technique on the Anterior Approach is also available and is Catalog Number 0612-15-511.

Acetabular Reaming

The goal of acetabular reaming is to restore the center of the natural acetabulum.

Initially, employ a grater 6–8 mm smaller than the anticipated acetabular component size to deepen the acetabulum to the level determined by pre-operative templating (Figures 15 and 16). Subsequent reaming should proceed in 1–2 mm increments. Center the graters in the acetabulum until the deepened socket becomes a true hemisphere. Use a curette to free all cysts of fibrous tissue. Pack any defects densely with cancellous bone.

It is important to understand that all PINNACLE Acetabular Hip System instrumentation is marked with true dimensions meaning, for example, a 54 mm grater reams a 54 mm cavity (Figure 17). The graters, shell trials and acetabular implants are all hemispherical and measure 180 degrees around the dome to the level of the coating on the final shell.

Under-reaming of the acetabulum to allow the press-fit of the final shell is dependent on bone quality and the size of the acetabular component. A 1 mm under-ream is usually sufficient in smaller sockets, while a larger socket may require a 1–2 mm under-ream. Likewise, soft bone will more readily accommodate a greater press-fit of the acetabular component than sclerotic bone.

In some patients, line-to-line reaming may be sufficient to achieve stability.

The orientation and depth of acetabular reaming often determines the orientation and depth of the final shell seating. It is important to ream where the final shell is to be positioned. As such, a part of the grater head will be visible on the superolateral rim when reaming (Figure 16).

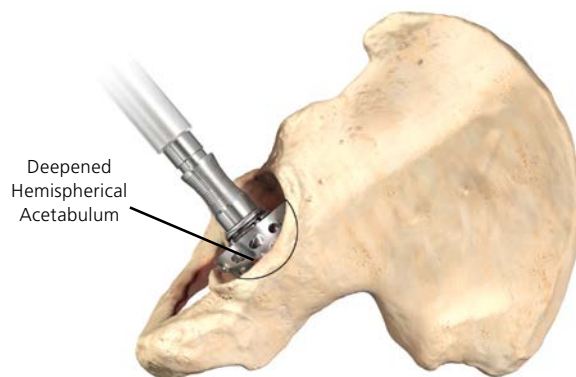

Figure 15: Acetabular Reaming

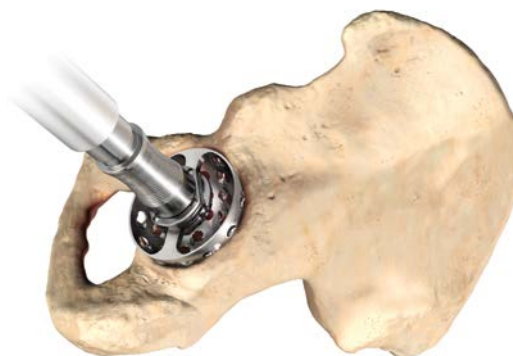

Figure 16: Acetabular Reaming

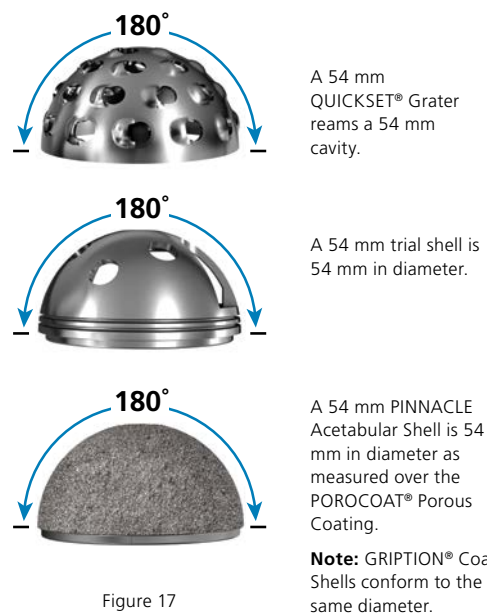

Figure 17

Acetabular Shell Trialing and Positioning

Peer-reviewed publications highlight the importance of acetabular component positioning in relation to short- and long-term outcomes during total hip arthroplasty for all types of bearing materials.²⁻⁹ Cup positioning should be varied to optimize fixation, range of motion and dislocation resistance and minimize the likelihood of subluxation, impingement and edge-loading. This may be assessed during pre-operative planning, acetabular preparation and shell trialing.

Sub-optimal component positioning may lead to edge loading, dislocation, increased wear and polyethylene fracture.²⁻⁹

Determining the Abduction Angle

The pre-operative A/P radiograph can help determine the targeted abduction angle and be helpful in determining how much of the acetabular component should be left uncovered to provide the proper implant abduction angle (Figures 18 and 19). The targeted shell abduction (as measured on radiographs) should be 40–45 degrees taking into account local soft tissue and anatomic landmarks. The landmarks for acetabular component positioning are the medial wall of the acetabulum (the radiographic tear drop) and the lateral-superior rim of the acetabulum.

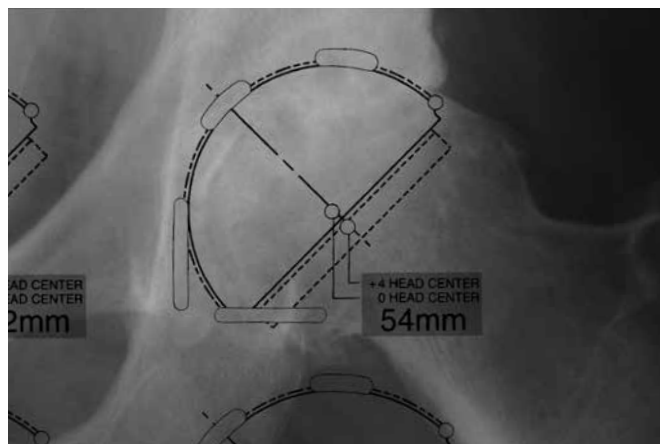

Figure 18: Pre-operative determination of abduction angle

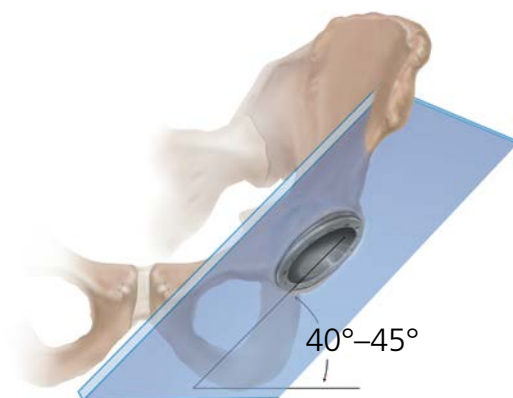

Figure 19: 40°–45° targeted shell abduction (as measured on radiographs)

Acetabular Shell Trialing and Positioning

Determining Proper Anteversion

The use of bony landmarks or the transverse acetabular ligament aids in determining anteversion.¹⁰ Other methods are subject to error through a change in patient position during the procedure. Defining the bony landmarks of the ischium and pubis during exposure greatly facilitates acetabular component positioning.

The plane created by the pubis and the ischium can serve as a guide for acetabular shell orientation. The shell should be slightly more anteverted than the pubis/ischial plane. This relationship should remain constant regardless of the depth of reaming, and the preoperative A/P X-ray can be helpful in determining how much of the acetabular component should be left uncovered to provide the proper implant abduction angle (Figure 20). The targeted shell anteversion (as measured on radiographs) should be 15–20 degrees taking into account local soft tissue and anatomic landmarks (Figure 21).

Shell trials in 1 mm incremental sizes are available to assess shell fit and orientation. Contingent on the quality of the prepared bone, select the acetabular trial equal to or 1 mm larger in diameter than the final grater size. The "true dimension" of the shell trial is as marked on each trial (i.e. a shell trial marked "54 mm" measures 54 mm in diameter at the rim). Peripheral rim ridges on the shell trial enhance the stability during trial reduction. Liner trials that are marked with an even size fit both even-sized and smaller odd-sized shell trials. For example, a 54 mm polyethylene liner trial fits both the 54 mm and the 53 mm shell trials (refer to Figure 24). Using shell and liner trials in conjunction with the femoral component trials aid in ensuring optimum position of the components.

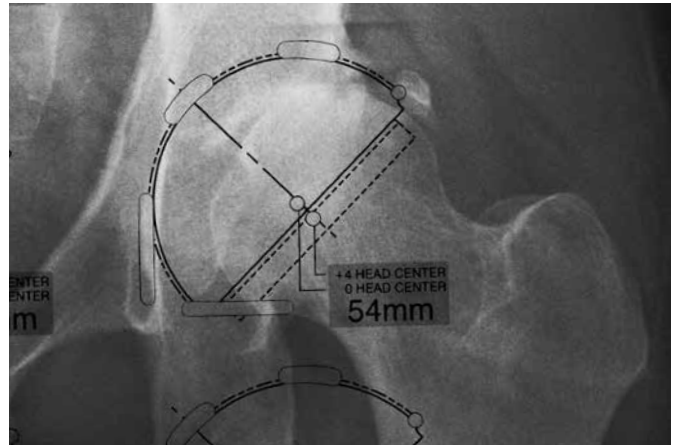

Figure 20: Pre-operative assessment of coverage of the acetabulum

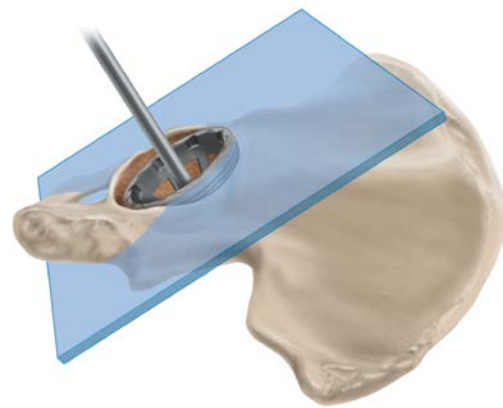

Figure 21: 15°–20° targeted shell anteversion (as measured on radiographs)

Determining Proper Anteversion

An alignment guide is provided to assist with shell positioning. However, shell orientation in the patient depends on patient position. The alignment guide does not allow for variation in patient position with respect to the operating table. It should be noted that patient orientation can vary throughout the procedure.

The PINNACLE Hip Alignment Guide System may be used to indicate an acceptable level of acetabular shell inclination and version. Once assembled, the inserter handle should be raised until the vertical bar is perpendicular to the plane of the operating table with the patient in the lateral decubitus position and the version guide parallel to the floor (Figure 22).

The inserter handle should then be rotated until the extended arm of the version guide is in line with the patient's longitudinal axis (Figure 23).

The extended arm of the version guide follows the long axis of the patient's body, corresponding to the affected hip, to achieve appropriate anteversion.

Confirm complete shell trial seating by sighting through the holes and cutouts in the acetabular shell trial. The screw hole pattern in the trial shell replicates the PINNACLE Sector Shell Implant screw hole pattern to assist with screw targeting.

Do not use the shell trial to prepare screw holes. Prepare screw holes only through the final implant.

The version guide is marked with 30 degree striations, which provides an indication of operative anteversion. Operative anteversion differs from radiographic anteversion due to the projection of angles on a radiograph. Therefore, the 30 degree striation equates to a radiographic anteversion of 20 degrees, as measured on postoperative radiographs.

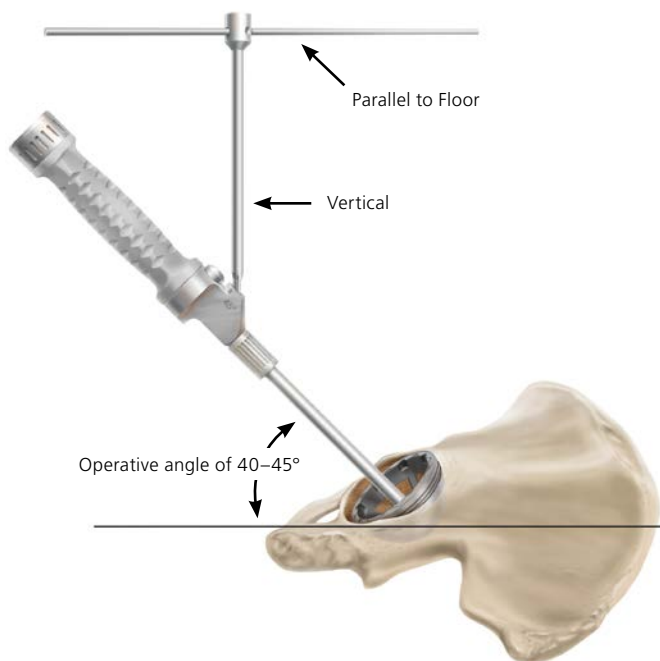

Figure 22: Hold the version guide parallel to the operating table to determine the abduction angle

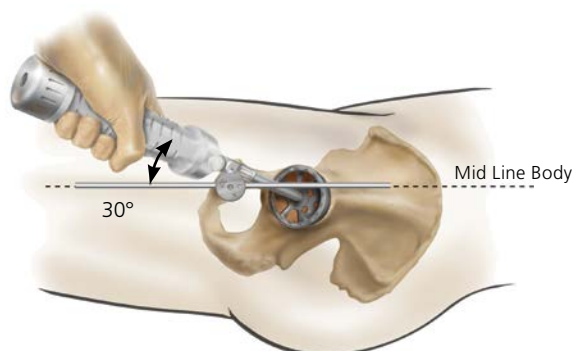

Figure 23: Position the extended arm of the version guide on the long body axis to determine anteversion

Acetabular Shell Trialing and Positioning

Polyethylene Liner Trials

Following positioning and seating of the acetabular shell trial, place the appropriate sized liner trial into the shell trial (Figure 24). Secure the liner trial to the shell trial through the apical hole screw using a standard hex head screwdriver. There are various liner configurations for all head sizes ranging from 28–44 mm. Refer to Figure 25 for details on the liner configurations.

With the femoral component trials in position, assess stability and range of motion. Couple the liner trial with the shell trial in the desired position. For liner alternatives other than neutral, there is an orientation reference etch mark on the liner trial and liner implant.

*Appropriate spacer trials to be utilized for head diameters of 32 and 36 mm.

Shell and Liner Trial Sizes

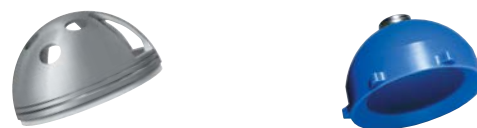

Shell Trial Size (mm)	Liner Trial Size (mm)
47, 48	48
49, 50	50
51, 52	52
53, 54	54
55, 56	56
57, 58	58
59, 60	60
61, 62	62
63, 64	64
65, 66	66
67, 68*	68
69, 70*	70
71, 72*	72

Figure 24

	Neutral	+4 Neutral	+4 10 Degree	Lipped
28 mm polyethylene trial liners are GREEN				
32 mm polyethylene trial liners are BLUE				
36 mm polyethylene trial liners are ORANGE				
40 mm polyethylene trial liners are PINK				

Figure 25

Polyethylene Liner Configurations

Within the PINNACLE Acetabular System, a variety of liner designs are available. Each design has specific benefits. It is important for the surgeon to understand the geometry of the various liner alternatives and their impact on joint biomechanics and range of motion.

Neutral Liner

The neutral liner provides 180 degrees of head coverage. The wide face chamfer is optimized for range of motion. The range of motion measured is 139 degrees with a SUMMIT® Tapered Stem and a 32 mm ARTICUL/EZE® Head. The femoral head's center of rotation is concentric with the outer diameter of the shell (Figure 26A).¹¹

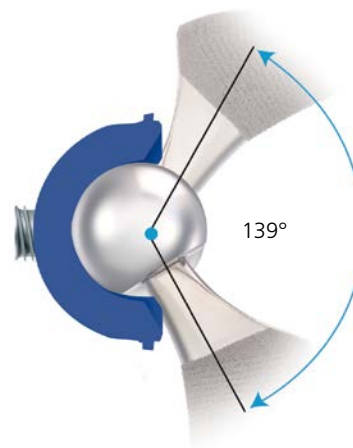

Figure 26A: Neutral Liner – 32 mm ID with SUMMIT® Tapered Hip System

+4 Neutral Liner

Like the neutral liner, the +4 neutral liner provides 180 degrees of head coverage. The wide face chamfer is optimized for range of motion. The range of motion measured is 139 degrees with a standard SUMMIT Stem and a 32 mm ARTICUL/EZE Head. This liner provides a 4 mm lateralization of the femoral head's center of rotation. This 4 mm offset both increases soft tissue tensioning and provides 4 mm of increased polyethylene thickness in the shell's dome region. This lateralized liner can be used as an alternative to a longer neck and may enable the surgeon to avoid using a skirted head. A +4 neutral liner will result in about 3 mm of additional leg length and about 3 mm of additional offset if the cup is inserted at a 45 degree abduction angle, as compared to a neutral liner (Figure 26B).¹¹

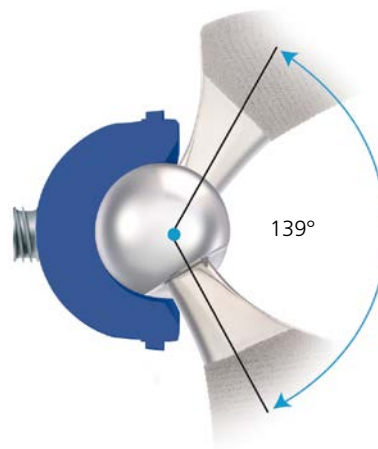

Figure 26B: +4 Neutral Liner – 32 mm ID with SUMMIT Hip Stem

Acetabular Shell Trialing and Positioning

+4 10-Degree (Face-Changing) Liners

Like the other liners, the +4 10 degree liner provides 180 degrees of head coverage, and the wide chamfer is optimized for range of motion, which is 134 degrees with a SUMMIT Stem and a 32 mm ARTICUL/EZE Head. This liner lateralizes the femoral head 4 mm, and a 10 degree face change alters inclination/version dependent upon placement of the liner (Figure 26C).¹¹

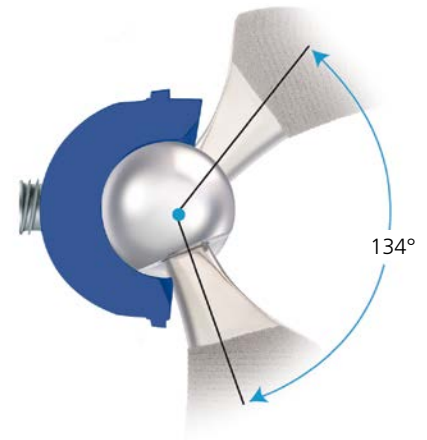

Figure 26C: +4 10 Degree Face-Changing Liner – 32 mm ID with SUMMIT Hip Stem

Lipped Liner

This liner provides 180 degrees of head coverage plus a 4 mm build-up for added stability. It also features a face-change of 15 degrees that will alter inclination/version dependent upon placement of the liner. The range of motion is measured at 130 degrees with a standard SUMMIT Stem and a 32 mm ARTICUL/EZE Head. The lip on this liner can provide additional stability; however, the impact on range of motion and early impingement must be understood (Figure 26D).¹¹

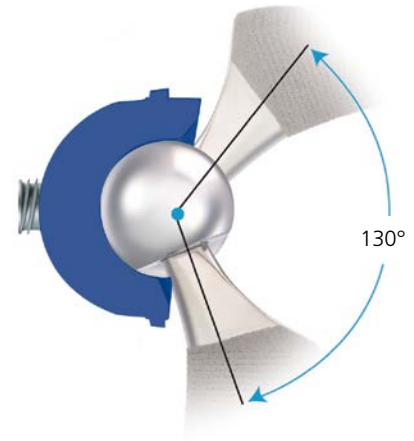

Figure 26D: Lipped Liner – 32 mm ID with SUMMIT Hip Stem

Constrained Liners

Constrained liners are available for the PINNACLE System and are described in the ESC® Liner Surgical Technique, Cat. No. 0608-58-000.

Polyethylene Liner Configurations

The range of motion (ROM) data of physiologically positioned acetabular and femoral components differs from the commonly discussed sweep angles outlined on the prior page. The physiologic ROM can be described by maximum achievable movement in flexion and extension and abduction and adduction.

The required ranges of angular movement between the acetabular and femoral components in a total hip joint replacement are specified in a well-recognized industry standard¹². In accordance with this standard, the table below was created to show the physiologic ROM data for combinations of PINNACLE Hip and the CORAIL[®] Hip System, including shells, inserts, femoral heads and femoral components, using 3-dimensional digital models¹¹ (Figure 27).

The acetabular component model was oriented into an initial position, which is considered a neutral position for a physiologically oriented acetabular cup component in terms of abduction and version. From the neutral position, the femoral stem was rotated until the neck of the stem made contact with the rim of the acetabular shell.

The angles achieved in each direction about each axis are shown in the following table (this data shows theoretical numbers and clinical results may be reduced due to skeletal impingement or the presence of soft tissues):

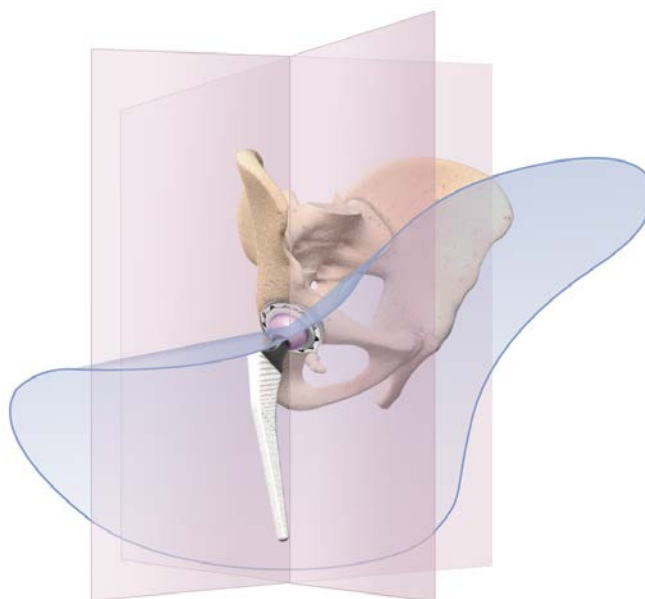

Figure 27

Liner Options

Head Size/ Liner Inner Diameter	Neutral		+4 Neutral		+4 10° Face		Lipped	
	Flexion/ Extension	Abduction/ Adduction	Flexion/ Extension	Abduction/ Adduction	Flexion/ Extension	Abduction/ Adduction	Flexion/ Extension	Abduction/ Adduction
28 mm	166°	119°	167°	121°	165°	115°	143°	105°
32 mm	177°	127°	177°	127°	172°	121°	151°	114°
36 mm	177°	127°	180°	128°	174°	122°	162°	123°
40 mm	189°	135°	177°	128°	173°	122°	N/A	N/A

Range of Motion (ROM) tested with a CORAIL Stem in accordance with ISO 21535:2007 (E) standard for a physiologically positioned shell and stem.¹²

Implanting the Acetabular Shell

Shell Insertion

Each PINNACLE Acetabular Shell style is implanted using the same basic surgical technique; however, some shell styles have technique-specific tips that help facilitate implantation. This technique demonstrates the insertion of a PINNACLE Hip 100 Series (no-hole) shell. Before implanting the final prosthesis, take the hip through a full range of motion and stability assessment with all trial components in position.

Securely thread the final acetabular shell prosthesis onto the impactor (Figure 28). Use the PINNACLE Hip external alignment guide to assist in component orientation (refer to Figures 22 and 23).

Since the natural acetabulum is inclined at an average angle of 50–55 degrees, a replacement acetabular component implanted at the correct position will have some shell coating visible above the rim of the acetabulum. To achieve the targeted shell position of 40–45 degrees of inclination and 15–20 degrees of anteversion, it is recommended that 4–6 mm of coating should be left exposed. It should be noted, however, that the amount of coating to be left visible is dependant on the angle of the patient's acetabulum and the size of the component used. The three anatomical regions indicated in Figure 29 assist with cup position.

After confirming alignment, impact the prosthesis into position. Given the nature of a hemispherical acetabular component, rim contact will occur before dome seating occurs. This may require additional impaction to ensure seating. Confirm seating by sighting through the apical hole or, if present, screw holes. An apical hole eliminator may be inserted with a standard hex head screwdriver following shell impaction. Following final component seating, if adjustments to the shell orientation are necessary, thread the impactor handle back into the apical hole to adjust the shell position. Avoid adjusting the shell position by impacting the Variable Interface Prosthesis (VIP) taper region and/or shell face with a punch or similar instrument, as this may cause damage to the VIP taper inside the PINNACLE Hip Shell.

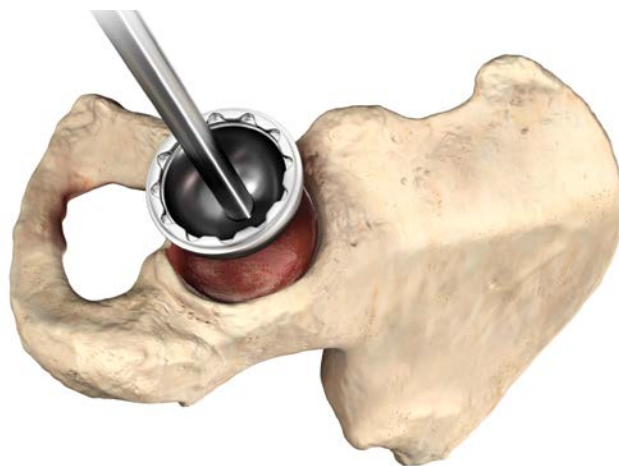

Figure 28

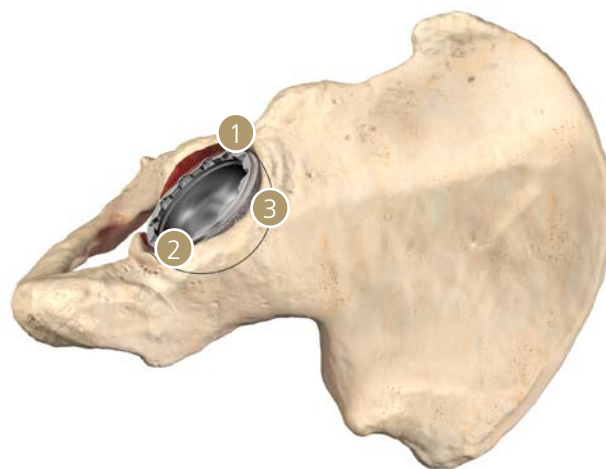

Figure 29: Confirm Acetabular Shell Alignment

- 1 Anterior notch**
Check for psoas tendon impingement with large diameter heads
- 2 Posterior**
Check toe-off impingement
- 3 Supero-lateral rim**
Shell coating / reamer visible

Implanting the Acetabular Shell with Screw Fixation

Screw Insertion

The PINNACLE System includes the Sector and Multi-hole shell options that are designed for insertion with screws. The Sector shell is referenced on the following pages to demonstrate the surgical technique for implantation of the shell with screw fixation.

QUICKSET® Acetabular Screw Instruments are recommended for screw insertion. The Sector shell has two medial hole alternatives, which are placed to enable screw placement up the posterior column in either the right or left hip. The single lateral screw provides additional access to the ilium.

Select holes where the prosthesis is to be anchored with cancellous screws so that the screws lie within a safe quadrant. The safe quadrant is defined by two lines from the anterior-inferior iliac spine through the center of the acetabulum and posterior by a line from the sciatic notch to the center of the acetabulum (Figure 30).

The 3.8 mm drill bit is controlled by the drill guide as it passes through selected holes into the acetabulum (Figure 31). The screw angle may vary by as much as a total of 34 degrees (Figure 32). The effective lengths of the 7 drill bits available are 25, 30, 35, 40, 45, 55, and 70 mm. By seating the drill bit completely into the guide, holes corresponding to the effective length of the drill bit will be created.

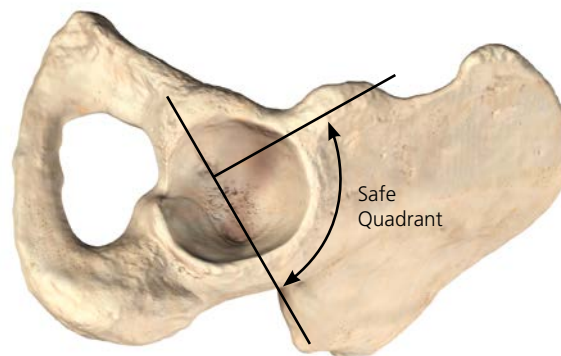

Figure 30

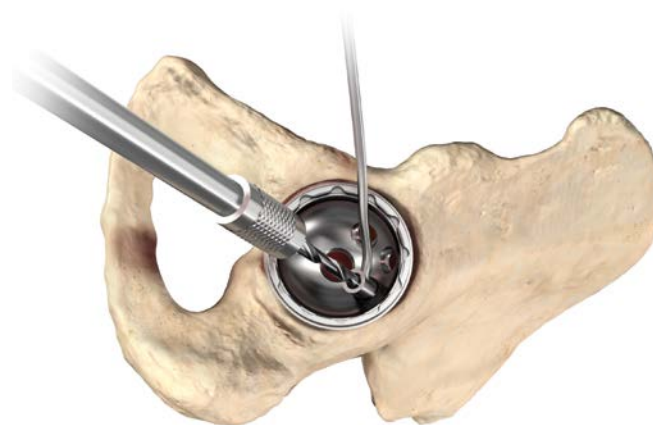

Figure 31: Drill Guide



Figure 32: Screw Angulation

Implanting the Acetabular Shell with Screw Fixation

Verify hole depth using the QUICKSET Depth Instruments Gauge. Alternating colors on the depth gauge represent 10 mm increments (Figure 33).

Insert 6.5 mm PINNACLE Hip Cancellous Bone Screws using a hex head screwdriver (Figures 34 and 35).

The 6.5 mm self-tapping screws have four-point cutting flutes with a blunt tip to reduce the risk of neurovascular injury (Figure 36).

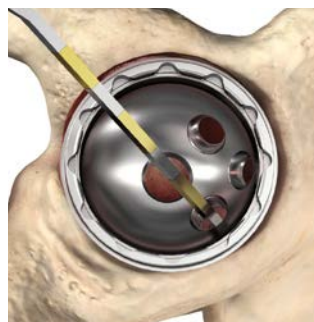

Figure 33: Depth Gauge

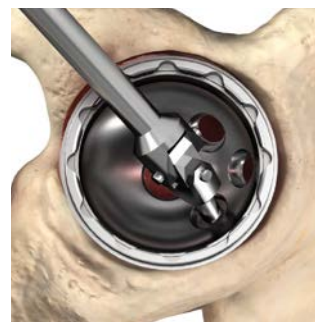

Figure 34: Screw Insertion



Figure 35: Screw Insertion

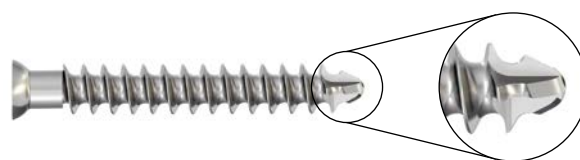

Figure 36: Screw Tip

Implanting the Acetabular Shell with Spikes

300 Series Shell Insertion

Spikes are placed along the radius of the PINNACLE Hip 300 Series Shell and are coated for additional fixation (Figures 37 and 38). The spike height in the 300 Series shell ensures that the spike contacts bone on insertion at the same point that the shell contacts the rim of the prepared acetabulum. This gives the surgeon greater control when inserting the 300 Series shell and ensures the shell bottoms out in the dome of the acetabulum.

The recommended acetabular reaming technique for the PINNACLE 300 Shell is either 1 mm under or line-to-line with the shell size dependent on bone quality. It is important that the cup is well centered in the prepared acetabular cavity in the predetermined alignment indicated by the trial before being impacted.

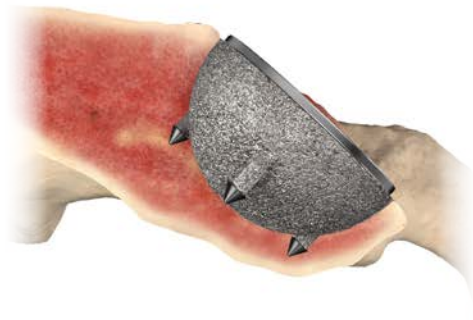

Figure 37: Prior to shell impaction, spikes and rim engage simultaneously when the shell is centered and aligned

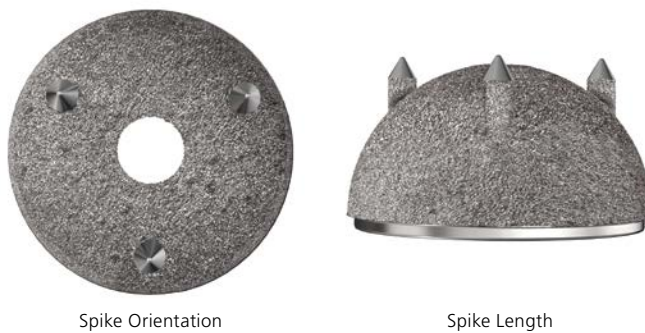

Figure 38

Polyethylene Liner Insertion and Impaction

Following insertion of the final acetabular shell and femoral component, the liner trials can be used in the shell to confirm liner selection and evaluate joint stability and range of motion. Prior to inserting the final acetabular liner, thoroughly irrigate and clean the shell. It is important to check the shell/liner locking groove for debris. Remove all soft tissue from the face of the shell so as not to impede liner seating (Figure 39) while also ensuring all screws (if used) are seated flush. An apex hole eliminator may be used prior to liner insertion.



Figure 39: Liner Insertion

Prior to insertion/impaction, mate the liner anti-rotational device (ARD) tabs with the ARD scallops on the shell (Figure 40). There are six ARD tabs on the liners and 12 ARD scallops for shell diameters 48–72 mm. There are four ARD tabs and eight ARD scallops in shell diameters 38–46 mm. This allows the liner to be rotated in 30 degree increments for shells 48–72 mm and 45 degree increments for 38–46 mm.



Figure 40: Align the liner anti-rotation tabs with shell scallops

Seat the liner using the inner diameter (ID) liner impactor that corresponds to the selected implant. Because the locking mechanism is tapered, it is important to impact the liner on-axis into the shell with multiple medium blows (Figure 41).

Impacting the liner in a tilted position may prevent complete seating.

Seating is visually confirmed when the liner ARDs are flush with the face of the acetabular shell; however, the liner face will remain proud in relation to the shell face by approximately 1 mm for a neutral liner to 4 mm for a lateralized liner (Figure 42).

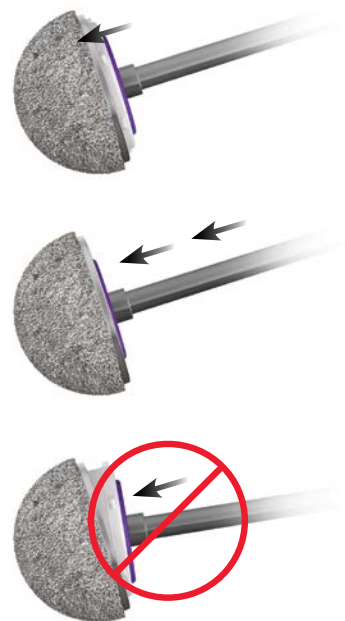

Figure 41: Liner Impactation

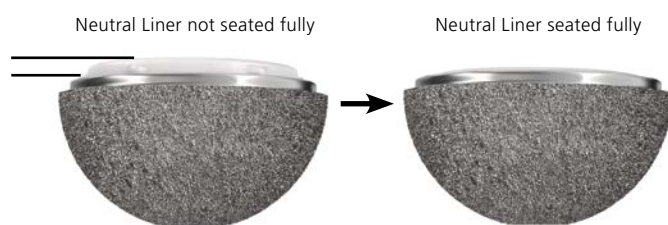

Figure 42: Liner Seating Height for a neutral liner

Polyethylene Liner Extraction

A polyethylene liner extractor is available to aid in polyethylene liner extraction and to help ensure the PINNACLE Shell is not damaged during polyethylene liner extraction (Figure 43).

Open the extractor jaws and extend the ARD pin from the extractor tip. Place the ARD pin into an empty ARD and tightly close the jaws of the extractor (Figure 44). The teeth of the extractor should dig into the inner diameter of the polyethylene.

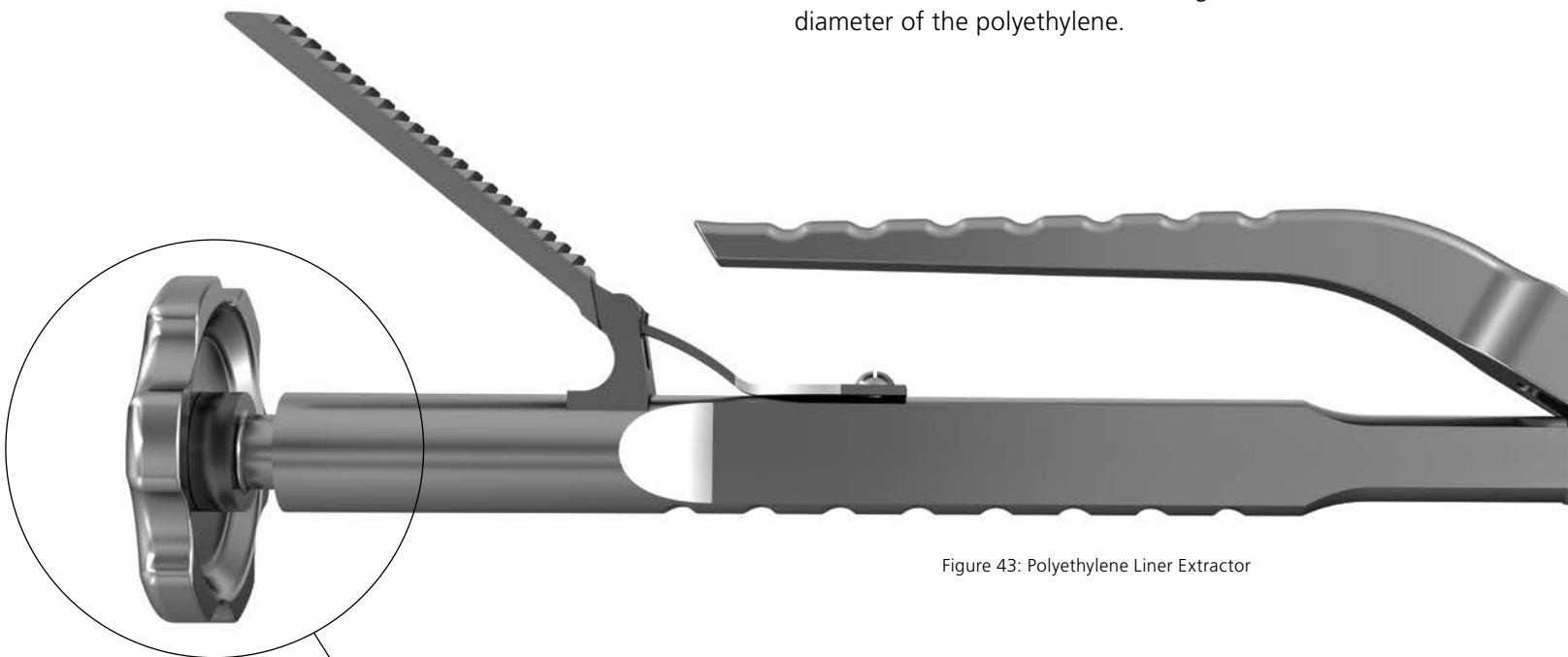

Figure 43: Polyethylene Liner Extractor

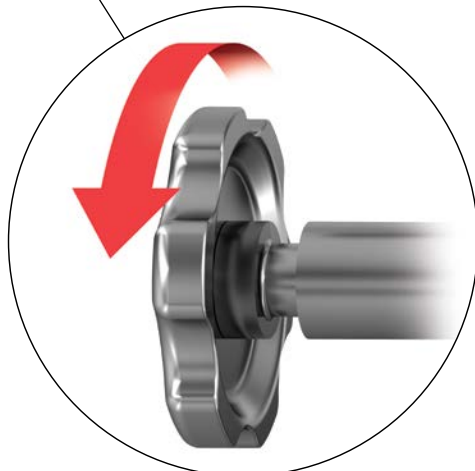

Figure 45

Once the ARD tip and teeth are secure on the polyethylene, advance the extraction knob clockwise until the polyethylene is removed (Figures 45 and 46).

Note: It is important to note that an extracted polyethylene liner cannot be reused.



Figure 44

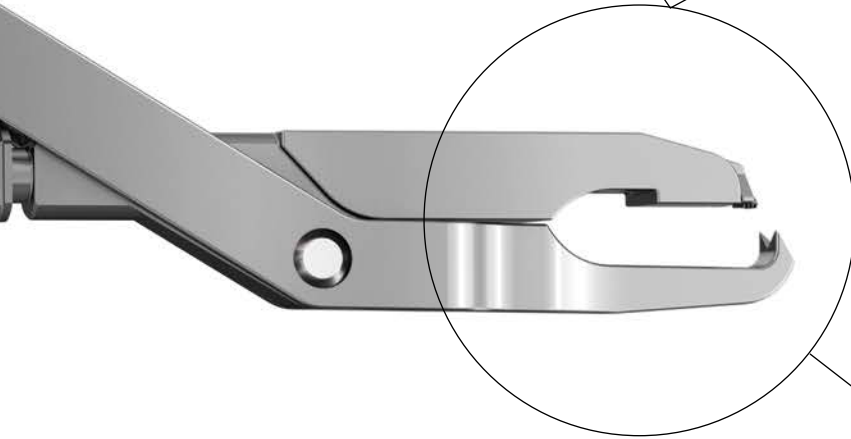
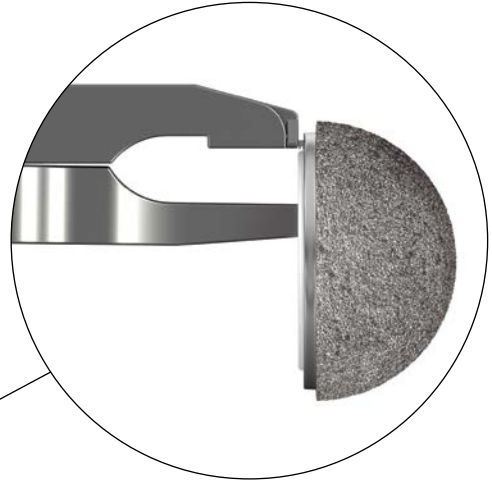

Figure 46

Functional Assessment

Select the appropriate femoral head, and place it onto the clean, dry trunion of the selected stem. Apply finger pressure to firmly seat the head onto the stem. Utilizing the femoral head impactor, impact the femoral head onto the stem with two moderate blows (Figures 47 and 48). Once the head is impacted, the hip is then reduced with final components in place.

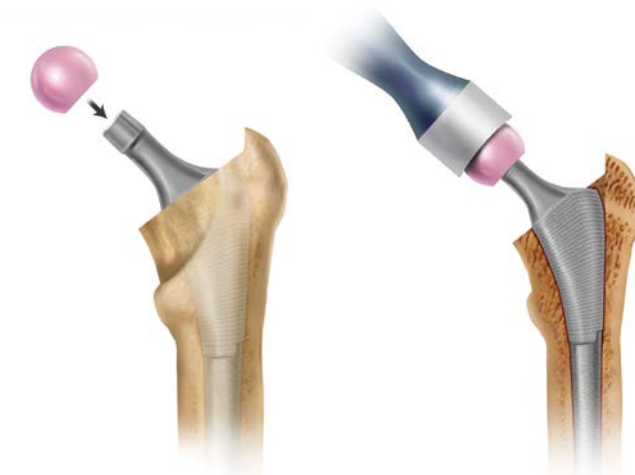

Figure 47

Figure 48

Correct component placement is critical for the longevity of the hip reconstruction. Figure 49 depicts the position of the femoral component neck with relation to the opening of the acetabular component with the reconstructed hip in neutral rotation.

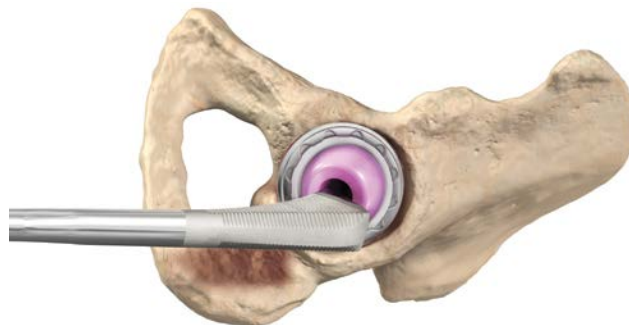

Figure 49

To assess the combined anteversion of the femoral stem and acetabular component, place the patient in the lateral decubitus position with the operative hip gently flexed and internally rotated (Figure 50) until the circumference of the femoral head becomes coplanar with the opening of the acetabular insert (i.e., the axis of the femoral neck is perpendicular to the insert face). This position is depicted through a frontal view in Figure 51 and through a lateral view in Figure 52.

The angle between horizontal and the internally rotated operative leg provides an estimate of combined anteversion of the acetabular component and the femoral stem. Combined anteversion at 30–40 degrees is generally acceptable.

Closure

Closure is based on the surgeon's preference and the individual case. If the capsule is retained, it is closed separately. The gluteus minimus and gluteus medius can be closed separately or as a single unit. At least one stitch is passed through bone. Tension is relieved during the repair with slight internal rotation. The repair should be tested throughout the hip range of motion.

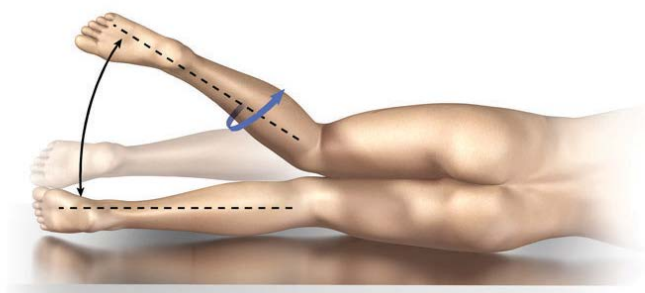

Figure 50: Combined Anteversion

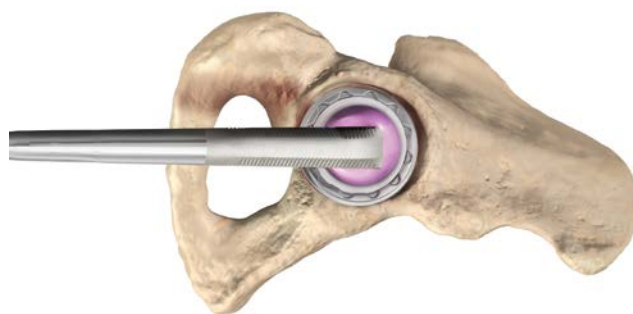

Figure 51

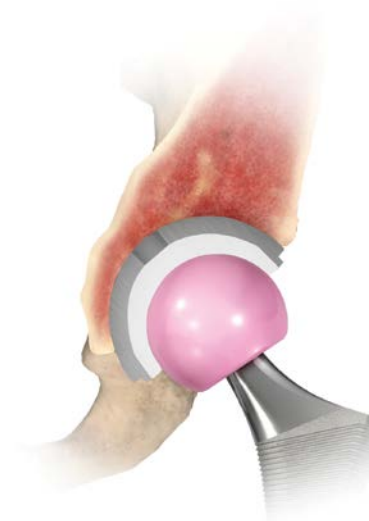

Figure 52

Tight Exposure and Stability Tips

Tight Exposure

If the exposure is tight, completely incise the anterior capsule, perform a partial or complete release of the gluteus maximus tendon and release the reflected head of the rectus femoris.

Stability Assessment

Posterior Instability

With the trial implants in place, place the hip in 90 degrees of flexion, neutral abduction and internally rotate until subluxation. If there is less than 60 degrees of internal rotation, determine the cause of instability.

Prosthetic Impingement

PROBLEM

- Femoral implant neck levers on the component rim.

SOLUTION

- Reposition shell to correct version/abduction.
- Increase head size and evaluate.
- Increase anteversion of the stem.

Bony Impingement

PROBLEM

- Prosthetic neck levers on anterior acetabular osteophyte.
- Greater trochanter impinging on ilium.

SOLUTION

- Remove anterior osteophytes from the acetabulum.
- Increase stem offset to move trochanter away from the ilium.
- Remove anterior trochanteric bone.

Soft Tissue Impingement

PROBLEM

- Redundant anterior capsule causes head to lever out of socket.

SOLUTION

- Resect redundant anterior capsule.

Soft Tissue Laxity

PROBLEM

- Lax soft tissue leading to multidirectional instability.

SOLUTION

- Increase the neck length.
- Advance the trochanter.

Stability Assessment

Anterior Instability

With the implant trial in place, place the hip in extension and maximally externally rotate; subluxation should not occur. If subluxation occurs, assess the following:

Prosthetic Impingement

PROBLEM

- Prosthetic neck impinges on the acetabular cup.

SOLUTION

- Reposition acetabular component to decrease anteversion.
- Decrease anteversion of the femoral stem.
- Increase the head size and re-evaluate.

Bony Impingement

PROBLEM

- Femur impinges on the ischium.

SOLUTION

- Increase femoral offset.
- Decrease acetabular or stem anteversion.

The Keys to Managing Stability Are:

1. Ensure the appropriate anteversion/abduction of the acetabular and femoral components.
2. Restore correct leg length and femoral offset.
3. Repair the posterior capsule and rotators.
4. Work with the patient to ensure appropriate post-operative precautions are followed.

The PINNACLE Hip Performance Instruments Advantage

Potential Operative Efficiency

The PINNACLE Acetabular Cup System allows surgeons to match the appropriate technology combination to each patient. The system's clinical results are demonstrated in a large multi-center study and the national joint registries.^{13,14,15} When coupled with the system flexibility and the PINNACLE Performance Instruments, the PINNACLE Acetabular Cup System can provide multiple solutions for both surgeons and patients.

Note: The PINNACLE Performance Instrumentation Guide Brochure (DSUS/JRC/0914/0454) lists all product codes and ordering information for these instrument kits.

Potential Operative Efficiency

The Smart Kitting of the PINNACLE Hip Performance Instruments enables 98% of PINNACLE Acetabular Shell cases to be completed with only 3 instrument trays for a reduced OR back-table footprint.*¹⁶

Smart Kitting design that enables 98% of PINNACLE Acetabular Shell System cases to be completed with only 3 trays of instruments¹⁶



*As compared to PINNACLE Core Kits and QUICKSET Grater Instrumentation

PINNACLE Hip Performance Instruments, Encouraging Operative Efficiency

The PINNACLE Hip Performance Instruments are also compatible with rigid sterile container systems that have the following potential advantages in US hospitals:

Case Study 1:

St. Rose Dominican Hospital, Sienna Campus in Henderson, NV.

Results showed a time savings for Central Sterile (CS) personnel of at least 5 minutes per instrument case due to the elimination of blue wrap.¹⁷

Over the course of a year, St. Rose also saved \$13,920 in disposable costs (not including other costs such as reprocessing due to wrap puncture or wet sets) and an estimated 325 hours a year of CS labor time.¹⁷

Case Study 2:







Lexington Medical Center in Lexington, KY.

This hospital saved over \$20,000 and almost 7,500 pounds of blue wrap in the first year of implementation of rigid sterile containers systems.¹⁸



In the subsequent year, Lexington Medical Center saved over \$48,000 and almost 12,000 pounds of blue wrap.¹⁸

Ordering Information

Shell Options

						
Size	100 Series POROCOAT Coating	100 Series GRIPTION® Porous Coating	100 Series DUOFIX® HA Coating	Sector POROCOAT Coating	Sector GRIPTION Coating	Sector DUOFIX Coating
44 mm	N/A	1217-31-044	N/A	N/A	N/A	N/A
46 mm	N/A	1217-31-046	N/A	N/A	N/A	N/A
48 mm	1217-01-048	1217-31-048	1217-11-048	1217-22-048	1217-32-048	1217-12-048
50 mm	1217-01-050	1217-31-050	1217-11-050	1217-22-050	1217-32-050	1217-12-050
52 mm	1217-01-052	1217-31-052	1217-11-052	1217-22-052	1217-32-052	1217-12-052
54 mm	1217-01-054	1217-31-054	1217-11-054	1217-22-054	1217-32-054	1217-12-054
56 mm	1217-01-056	1217-31-056	1217-11-056	1217-22-056	1217-32-056	1217-12-056
58 mm	1217-01-058	1217-31-058	1217-11-058	1217-22-058	1217-32-058	1217-12-058
60 mm	1217-01-060	1217-31-060	1217-11-060	1217-22-060	1217-32-060	1217-12-060
62 mm	1217-01-062	1217-31-062	1217-11-062	1217-22-062	1217-32-062	1217-12-062
64 mm	1217-01-064	1217-31-064	1217-11-064	1217-22-064	1217-32-064	1217-12-064
66 mm	1217-01-066	1217-31-066	1217-11-066	1217-22-066	1217-32-066	1217-12-066

			
Size	300 Series POROCOAT Coating	Multi-Hole POROCOAT Coating	Multi-Hole GRIPTION Coating
48 mm	1217-03-048	1217-20-048	1217-30-048
50 mm	1217-03-050	1217-20-050	1217-30-050
52 mm	1217-03-052	1217-20-052	1217-30-052
54 mm	1217-03-054	1217-20-054	1217-30-054
56 mm	1217-03-056	1217-20-056	1217-30-056
58 mm	1217-03-058	1217-20-058	1217-30-058
60 mm	1217-03-060	1217-20-060	1217-30-060
62 mm	1217-03-062	1217-20-062	1217-30-062
64 mm	1217-03-064	1217-20-064	1217-30-064
66 mm	1217-03-066	1217-20-066	1217-30-066
68 mm	N/A	1217-20-068	1217-30-068
70 mm	N/A	1217-20-070	1217-30-070
72 mm	N/A	1217-20-072	1217-30-072

		
Size	Bantam POROCOAT Coating	Bantam GRIPTION Coating
38 mm	1217-20-038	1217-30-038
40 mm	1217-20-040	1217-30-040
42 mm	1217-20-042	1217-30-042
44 mm	1217-20-044	1217-30-044
46 mm	1217-20-046	1217-30-046

Apex Hole Eliminator

	Cat. No.
38–42 mm	N/A
48–66 mm	1246-03-000

PINNACLE Screw Options

6.5 Cancellous Dome Screws

Length	Cat. No.
8 mm	1217-08-500
15 mm	1217-15-500
20 mm	1217-20-500
25 mm	1217-25-500
30 mm	1217-30-500
35 mm	1217-35-500
40 mm	1217-40-500
45 mm	1217-45-500
50 mm	1217-50-500
55 mm	1217-55-500
60 mm	1217-60-500
65 mm	1217-65-500
70 mm	1217-70-500



Ordering Information

Metal Femoral Head Options

ARTICUL/EZE 12/14 M-Spec Metal Heads



Size	OD	Cat. No.
+1.5	28 mm	1365-11-500
+5		1365-12-500
+8.5		1365-13-500
-2	36 mm	1365-50-000
+1.5		1365-51-000
+5		1365-52-000
+8.5		1365-53-000
+12		1365-54-000
+15.5		1365-55-000
-2	40 mm	1365-04-000
+1.5		1365-05-000
+5		1365-06-000
+8.5		1365-07-000
+12		1365-08-000
+15.5		1365-09-000

ARTICUL/EZE 12/14 Standard Metal Heads



Size	OD	Cat. No.
+4	22.225 mm	1365-29-000
+7		1365-30-000
+1.5	28 mm	1365-11-000
+5		1365-12-000
+8.5		1365-13-000
+12		1365-14-000*
+15.5		1365-15-000*
+1	32 mm	1365-21-000
+5		1365-22-000
+9		1365-23-000
+13		1365-24-000*

S-ROM® 11/13 M-Spec Metal Heads



Size	OD	Cat. No.
+0	28 mm	1365-16-500
+3		1365-17-500
+6		1365-18-500
-3	36 mm	1365-26-000
+0		1365-31-000
+3		1365-32-000
+6		1365-33-000
+9		1365-34-000
+12	1365-36-000	
-3	40 mm	1365-41-500
+0		1365-42-500
+3		1365-43-500
+6		1365-44-500
+9		1365-45-500
+12		1365-47-500

S-ROM 11/13 Standard Metal Heads



Size	OD	Cat. No.
+0	22.225 mm	52-2002
+0	28 mm	52-2028
+3		87-5953
+6		52-2029
+9		87-5954*
+12		52-2030*
+0	32 mm	52-2032
+3		87-5955
+6		52-2033
+9		87-5956
+12		52-2034*

* Skirted heads

Ceramic Femoral Head Options

ARTICUL/EZE 12/14 BIOLOX® *delta* Ceramic Heads



Size	OD	Cat. No.
+1.5	28 mm	1365-28-310
+5		1365-28-320
+8.5		1365-28-330
<hr/>		
+1	32 mm	1365-32-310
+5		1365-32-320
+9		1365-32-330
<hr/>		
+1.5	36 mm	1365-36-310
+5		1365-36-320
+8		1365-36-330
+12		1365-36-340

ARTICUL/EZE 12/14 BIOLOX *delta* TS Ceramic Heads



Size	OD	Cat. No.
+1.5	28 mm	1365-28-710
+5		1365-28-720
+8.5		1365-28-730
+12		1365-28-740
<hr/>		
+1	32 mm	1365-32-710
+5		1365-32-720
+9		1365-32-730
<hr/>		
+1.5	36 mm	1365-36-710
+5		1365-36-720
+8.5		1365-36-730
+12		1365-36-740
<hr/>		
+1.5	40 mm	1365-40-710
+5		1365-40-720
+8.5		1365-40-730
+12		1365-40-740

S-ROM 11/13 BIOLOX *delta* Ceramic Heads



Size	OD	Cat. No.
+0	28 mm	1365-28-210
+3		1365-28-220
+6		1365-28-230
<hr/>		
+0	32 mm	1365-32-210
+3		1365-32-220
+6		1365-32-230
<hr/>		
+0	36 mm	1365-36-210
+3		1365-36-220
+6		1365-36-230
+9		1365-36-240
+12		1365-36-250

Ordering Information

ALTRX[®] Polyethylene Liner Options

28 mm



Neutral

+4 Neutral

+4 10°

Lipped

44 mm	1221-28-044	-	1221-28-144	-
46 mm	1221-28-046	-	1221-28-146	-
48 mm	1221-28-048	1221-28-448	1221-28-148	1221-28-248
50 mm	1221-28-050	1221-28-450	1221-28-150	1221-28-250
52 mm	1221-28-052	1221-28-452	1221-28-152	1221-28-252
54 mm	1221-28-054	1221-28-454	1221-28-154	1221-28-254
56 mm	1221-28-056	1221-28-456	1221-28-156	1221-28-256
58 mm	1221-28-058	1221-28-458	1221-28-158	1221-28-258
60 mm	1221-28-060	1221-28-460	1221-28-160	1221-28-260
62 mm	1221-28-062	1221-28-462	1221-28-162	1221-28-262
64 mm	1221-28-064	1221-28-464	1221-28-164	1221-28-264
66 mm	1221-28-066	1221-28-466	1221-28-166	1221-28-266

32 mm



Neutral

+4 Neutral

+4 10°

Lipped

48 mm	1221-32-048	1221-32-448	1221-32-148	-
50 mm	1221-32-050	1221-32-450	1221-32-150	-
52 mm	1221-32-052	1221-32-452	1221-32-152	1221-32-252
54 mm	1221-32-054	1221-32-454	1221-32-154	1221-32-254
56 mm	1221-32-056	1221-32-456	1221-32-156	1221-32-256
58 mm	1221-32-058	1221-32-458	1221-32-158	1221-32-258
60 mm	1221-32-060	1221-32-460	1221-32-160	1221-32-260
62 mm	1221-32-062	1221-32-462	1221-32-162	1221-32-262
64 mm	1221-32-064	1221-32-464	1221-32-164	1221-32-264
66 mm	1221-32-066	1221-32-466	1221-32-166	1221-32-266
68 mm	1221-32-068	1221-32-468	1221-32-168	-
70 mm	1221-32-070	1221-32-470	1221-32-170	-
72 mm	1221-32-072	1221-32-472	1221-32-172	-
74 mm	1221-32-074	1221-32-474	1221-32-174	-
76 mm	1221-32-076	1221-32-476	1221-32-176	-

36 mm



Neutral

+4 Neutral

+4 10°

Lipped

52 mm	1221-36-052	1221-36-452	1221-36-152	-
54 mm	1221-36-054	1221-36-454	1221-36-154	-
56 mm	1221-36-056	1221-36-456	1221-36-156	1221-36-256
58 mm	1221-36-058	1221-36-458	1221-36-158	1221-36-258
60 mm	1221-36-060	1221-36-460	1221-36-160	1221-36-260
62 mm	1221-36-062	1221-36-462	1221-36-162	1221-36-262
64 mm	1221-36-064	1221-36-464	1221-36-164	1221-36-264
66 mm	1221-36-066	1221-36-466	1221-36-166	1221-36-266
68 mm	1221-36-068	1221-36-468	1221-36-168	-
70 mm	1221-36-070	1221-36-470	1221-36-170	-
72 mm	1221-36-072	1221-36-472	1221-36-172	-
74 mm	1221-36-074	1221-36-474	1221-36-174	-
76 mm	1221-36-076	1221-36-476	1221-36-176	-

40 mm



Neutral

+4 Neutral

+4 10°

56 mm	1221-40-056	1221-40-456	1221-40-156
58 mm	1221-40-058	1221-40-458	1221-40-158
60 mm	1221-40-060	1221-40-460	1221-40-160
62 mm	1221-40-062	1221-40-462	1221-40-162
64 mm	1221-40-064	1221-40-464	1221-40-164
66 mm	1221-40-066	1221-40-466	1221-40-166
68 mm	1221-40-068	1221-40-468	1221-40-168
70 mm	1221-40-070	1221-40-470	1221-40-170
72 mm	1221-40-072	1221-40-472	1221-40-172
74 mm	1221-40-074	1221-40-474	1221-40-174
76 mm	1221-40-076	1221-40-476	1221-40-176



Ordering Information

MARATHON® Cross-Linked Polyethylene Liner Options

22.225 mm



Neutral

38 mm	1219-22-038
40 mm	1219-22-040
42 mm	1219-22-042
44 mm	1219-22-044
46 mm	1219-22-046

28 mm



Neutral



+4 Neutral



+4 10°



Lipped

	Neutral	+4 Neutral	+4 10°	Lipped
44 mm	1219-28-044	-	1219-28-144	-
46 mm	1219-28-046	-	1219-28-146	-
48 mm	1219-28-048	1219-28-448	1219-28-148	1219-28-248
50 mm	1219-28-050	1219-28-450	1219-28-150	1219-28-250
52 mm	1219-28-052	1219-28-452	1219-28-152	1219-28-252
54 mm	1219-28-054	1219-28-454	1219-28-154	1219-28-254
56 mm	1219-28-056	1219-28-456	1219-28-156	1219-28-256
58 mm	1219-28-058	1219-28-458	1219-28-158	1219-28-258
60 mm	1219-28-060	-	1219-28-160	-
62 mm	1219-28-062	-	1219-28-162	-

32 mm



Neutral

+4 Neutral

+4 10°

Lipped

	Neutral	+4 Neutral	+4 10°	Lipped
48 mm	-	1219-32-448	1219-32-148	-
50 mm	-	1219-32-450	1219-32-150	-
52 mm	1219-32-052	1219-32-452	1219-32-152	1219-32-252
54 mm	1219-32-054	1219-32-454	1219-32-154	1219-32-254
56 mm	1219-32-056	1219-32-456	1219-32-156	1219-32-256
58 mm	1219-32-058	1219-32-458	1219-32-158	1219-32-258
60 mm	1219-32-060	1219-32-460	1219-32-160	1219-32-260
62 mm	1219-32-062	1219-32-462	1219-32-162	1219-32-262
64 mm	1219-32-064	1219-32-464	1219-32-164	1219-32-264
66 mm	1219-32-066	1219-32-466	1219-32-166	1219-32-266
68 mm	-	1219-32-468	-	1219-32-268
70 mm	-	1219-32-470	-	1219-32-270
72 mm	-	1219-32-472	-	1219-32-272

36 mm



Neutral

+4 Neutral

+4 10°

	Neutral	+4 Neutral	+4 10°
52 mm	-	1219-36-452	1219-36-152
54 mm	-	1219-36-454	1219-36-154
56 mm	1219-36-056	1219-36-456	1219-36-156
58 mm	1219-36-058	1219-36-458	1219-36-158
60 mm	1219-36-060	1219-36-460	1219-36-160
62 mm	1219-36-062	1219-36-462	1219-36-162
64 mm	1219-36-064	1219-36-464	1219-36-164
66 mm	1219-36-066	1219-36-466	1219-36-166
68 mm	1219-36-068	1219-36-468	1219-36-168
70 mm	1219-36-070	1219-36-470	1219-36-170
72 mm	1219-36-072	1219-36-472	1219-36-172

Polyethylene Liner Thickness

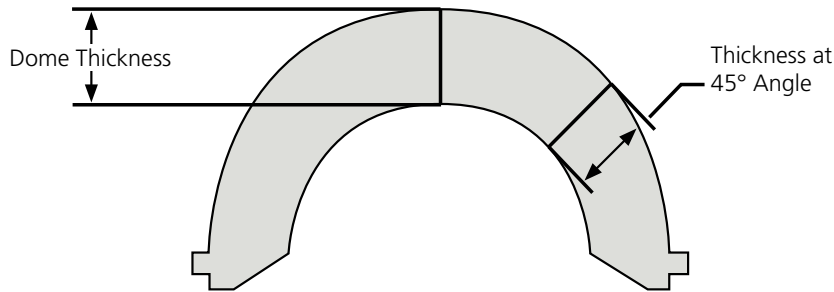

	22.225 mm Neutral		28 mm Neutral		28 mm +4 Neutral		28 mm +4 10°		28 mm Lipped		32 mm Neutral		32 mm +4 Neutral		32 mm +4 10°	
	Dome (mm)	45 Degree (mm)	Dome (mm)	45 Degree (mm)	Dome (mm)	45 Degree (mm)	Dome (mm)	45 Degree (mm)	Dome (mm)	45 Degree (mm)	Dome (mm)	45 Degree (mm)	Dome (mm)	45 Degree (mm)	Dome (mm)	45 Degree (mm)
38	5.6	5.0														
40	6.6	6.0														
42	7.6	6.9														
44	8.6	7.9	5.5	4.9			7.5	6.1								
46	9.6	8.9	6.5	5.9			8.5	7.1								
48			6.7	6.4	9.5	8.1	9.5	8.1	6.7	6.4	5.9	5.1	7.5	6.1	7.5	6.1
50			7.7	7.4	10.5	9.2	10.5	9.2	7.7	7.4	6.3	5.6	8.5	7.1	8.5	7.2
52			8.1	8.0	11.5	10.2	11.5	10.2	8.2	8.0	6.9	6.5	9.5	8.2	9.5	8.2
54			8.5	8.5	12.5	11.2	12.5	11.2	8.5	8.5	7.9	7.5	10.5	9.2	10.5	9.2
56			9.5	9.5	13.5	12.2	13.7	12.2	9.5	9.5	8.3	8.0	11.5	10.2	11.5	10.2
58			10.3	10.3	14.3	12.9	14.3	12.9	10.3	10.3	8.3	8.3	12.3	10.9	12.3	10.9
60			11.0	11.0	15.0	13.7	15.0	13.7	11.0	11.0	9.0	9.0	13.0	11.7	13.0	11.6
62			11.8	11.8	15.8	14.4	15.8	14.4	11.8	11.8	9.8	9.8	13.8	12.4	13.8	12.4
64			12.5	12.5	16.5	15.2	16.5	15.2	12.5	12.5	10.5	10.5	14.5	13.2	14.5	13.2
66			13.3	13.3	17.3	16.0	17.3	16.0	13.3	13.3	11.3	11.3	15.3	13.9	15.3	13.9
68											12.0	12.0	16.0	14.7	16.0	14.7
70											13.0	13.0	17.0	15.7	17.0	15.7
72											14.0	14.0	18.0	16.7	18.0	16.7
74											15.0	15.0	19.0	17.7	19.0	17.7
76											16.0	16.0	20.0	18.7	20.0	18.7

32 mm Lipped		36 mm Neutral		36 mm +4 Neutral		36 mm +4 10°		36 mm Lipped		40 mm Neutral		40 mm +4 Neutral		40 mm +4 10°		
Dome (mm)	45 Degree (mm)	Dome (mm)	45 Degree (mm)	Dome (mm)	45 Degree (mm)	Dome (mm)	45 Degree (mm)	Dome (mm)	45 Degree (mm)	Dome (mm)	45 Degree (mm)	Dome (mm)	45 Degree (mm)	Dome (mm)	45 Degree (mm)	
																38
																40
																42
																44
																46
																48
																50
6.9	6.5	5.5	4.9	7.5	6.2	7.5	6.2									52
7.9	7.5	5.6	5.3	8.5	7.2	8.5	7.2									54
8.3	8.0	6.7	6.3	9.5	8.2	9.5	8.2	7.6	6.9	5.6	4.9	7.5	6.2	7.5	6.1	56
8.3	8.3	7.1	6.8	10.3	8.9	10.3	8.9	7.1	6.9	6.3	5.6	8.3	6.9	8.3	6.9	58
9.0	9.0	7.5	7.3	11.0	9.7	11.0	9.7	7.0	7.0	6.0	5.7	9.0	7.6	9.0	7.7	60
9.8	9.8	7.7	7.7	11.8	10.4	11.8	10.4	7.7	7.7	5.7	5.7	9.8	8.4	9.8	8.4	62
10.5	10.5	8.5	8.5	12.5	11.2	12.5	11.2	8.5	8.5	6.5	6.5	10.5	9.2	10.5	9.2	64
11.3	11.3	9.2	9.2	13.3	11.9	13.3	11.9	9.2	9.2	7.2	7.2	11.3	9.9	11.3	9.9	66
12.0	12.0	10.0	10.0	14.0	12.7	14.0	12.7			8.0	8.0	12.0	10.7	12.0	10.7	68
13.0	13.0	11.0	11.0	15.0	13.7	15.0	13.7			9.0	9.0	13.0	11.7	13.0	11.7	70
14.0	14.0	12.0	12.0	16.0	14.7	16.0	14.7			10.0	10.0	14.0	12.7	14.0	12.7	72
		13.0	13.0	17.0	15.7	17.0	15.7			11.0	11.0	15.0	13.7	15.0	13.7	74
		14.0	14.0	18.0	16.7	18.0	16.7			12.0	12.0	16.0	14.7	16.0	14.7	76

Shell Size (OD) mm

Additional Instructions

- Use caution when handling ceramic components during assembly to avoid damage to components.
- It is important not to disassemble/reassemble the ceramic femoral head from the mating femoral stem. Doing so may damage these mating surfaces and lead to early failure.
- Ensure that the outer diameter of the femoral head matches the inner diameter of the acetabular liner by verifying labeling. Sizing mismatch may result in premature implant failure.
- While rare, ceramic head fracture may occur and requires care in the retrieval of all particles from the operative site. Carefully remove any ceramic particles or shards manually or with a pulse lavage. Remove any tissue which may have been affected by abrasion particles.
- Examine instruments and confirm functionality prior to use. Instruments that have been subjected to overuse or misuse conditions are susceptible to failure or may damage implants and should not be used.

References:

1. Learmonth ID, Young C, Rorabeck C. The operation of the century: total hip replacement. *Lancet* 2007;370:1508-19.
2. Brodner W, Gröbl A, Jankovsky R, Meisinger V, Lehr S, Gottsauner-Wolf FJ. Cup inclination and serum concentration of cobalt and chromium after metal-on-metal total hip arthroplasty. *J Arthroplasty*. 2004;19(8 Suppl 3):66-70.
3. Williams S, Leslie I, Isaac G, Jin Z, Ingham E, Fisher J. Tribology and wear of metal-on-metal hip prostheses: influence of cup angle and head position. *J Bone Joint Surg*. 2008;90A (Suppl 3):111-7.
4. Udomkiat P, Dorr LD, Wan Z. Cementless hemispheric porous-coated sockets implanted with press-fit technique without screws: average ten-year follow-up. *J Bone Joint Surg*. 2002;84A:1195-200.
5. Schmalzried TP, Guttman D, Grecula M, Amstutz H. The relationship between the design, position, and articular wear of acetabular components inserted without cement and the development of pelvic osteolysis. *J Bone Joint Surg*.1994;76A:677-688.
6. Kennedy JG, Rogers WB, Soffee KE, et al. Effect of acetabular component orientation on recurrent dislocation, pelvic osteolysis, polyethylene wear and component migration. *J Arthroplasty* 1998;13:530-534.
7. Prudhommeaux F, Hamadouche M, Nevelos J, et al. Wear of alumina-on-alumina total hip arthroplasty at a mean 11-year followup. *Clin Orthop Relat Res*. 2000; 397:113.
8. Walter WL, O'Toole GC, Walter WK, Ellis A, Zicat BA. Squeaking in ceramic-on-ceramic hips: the importance of acetabular component orientation. *J Arthroplasty*. 2007;22:496-503.
9. Tower SS, Currier JH, Currier BH, Lyford KA, Van Citters DW, Mayor MB. Rim cracking of the cross-linked longevity polyethylene acetabular liner after total hip arthroplasty. *J Bone Joint Surg*. 2007;89A(10):2212-7.
10. Archbold HAP et al. The transverse acetabular ligament: an aid to orientation of the acetabular component during primary total hip replacement. *J Bone Joint Surg*. 2006;88B:883-6.
11. Data on file – Poly ROM All Heads and Stems
12. Data on file – DVE-001038-ROM October 2013
13. National Joint Registry for England and Wales, 13th Annual Report, 2016.
14. Barrett W, Kindsfater K, Dowd J, and Lesko J. Long-Term Total Hip Arthroplasty with a Modular Cup: Results of a Large Multi-Center Study. Abstract Submitted, AAOS, June 1, 2013.
15. Australian Orthopaedic Association National Joint Replacement Registry. Annual Report, Adelaide: AOA, 2016. Table HT14. Retrieved from: <https://aoanjrr.sahmri.com/en/annual-reports-2016>.

Extracted from Table HT14 Cumulative Percent Revision of Primary Total Conventional Hip Replacement with Cementless Fixation

Femoral Component	Acetabular Component	N Revised	N Total	1 Yr	3 Yrs	5 Yrs	7 Yrs	10 Yrs	15 Yrs
Corail	Pinnacle	854	32072	1.7 (1.6, 1.9)	2.6 (2.4, 2.8)	3.2 (2.9, 3.4)	3.8 (3.5, 4.1)	5.0 (4.4, 5.8)	

16. Data on File, DePuy Orthopaedics, Inc. Warsaw, IN,. Pinnacle Shell Sales Distribution 2011
17. Campbell, Barbara. Containerizing Orthopaedic instrument sets save labor, money and time. Reprinted from January 1, 2005. Aesculap, Inc.
18. SurgicalProductsMag.com. Going from Blue to Green. April, 2011. Retrieved from: <http://www.surgicalproductsmag.com/article/2011/04/going-blue-green>.

BioloX® is a registered trademark of CeramTec GmbH.

The third party trademarks used herein are the trademarks of their respective owners.

Limited Warranty and Disclaimer: DePuy Synthes products are sold with a limited warranty to the original purchaser against defects in workmanship and materials. Any other express or implied warranties, including warranties of merchantability or fitness, are hereby disclaimed.

Please also refer to the package insert(s) or other labeling associated with the devices identified in this surgical technique for additional information.

CAUTION: Federal Law restricts these devices to sale by or on the order of a physician.

Some devices listed in this surgical technique may not have been licensed in accordance with Canadian law and may not be for sale in Canada.

Please contact your sales consultant for items approved for sale in Canada.

Not all products may currently be available in all markets.



DePuy Orthopaedics, Inc.

700 Orthopaedic Drive
Warsaw, IN 46582
USA
Tel: +1 (800) 366-8143
Fax: +1 (800) 669-2530

www.depuysynthes.com

DePuy (Ireland)

Loughbeg, Ringaskiddy
Co. Cork
Ireland
Tel: + 353 21 4914 000
Fax: + 353 21 4914 199